

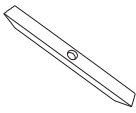

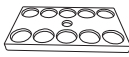



BOŽKOV BOŽANICE

MANUÁL A PRAVIDLA HRY

SEZNAM KOMPONENTŮ

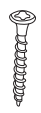
								
A - 1 ks	B - 1 ks	C - 1 ks	D - 2 ks	E - 2 ks	F - 2 ks	a - 2 ks	b - 1 ks	c - 2 ks

MONTÁŽNÍ NÁVOD

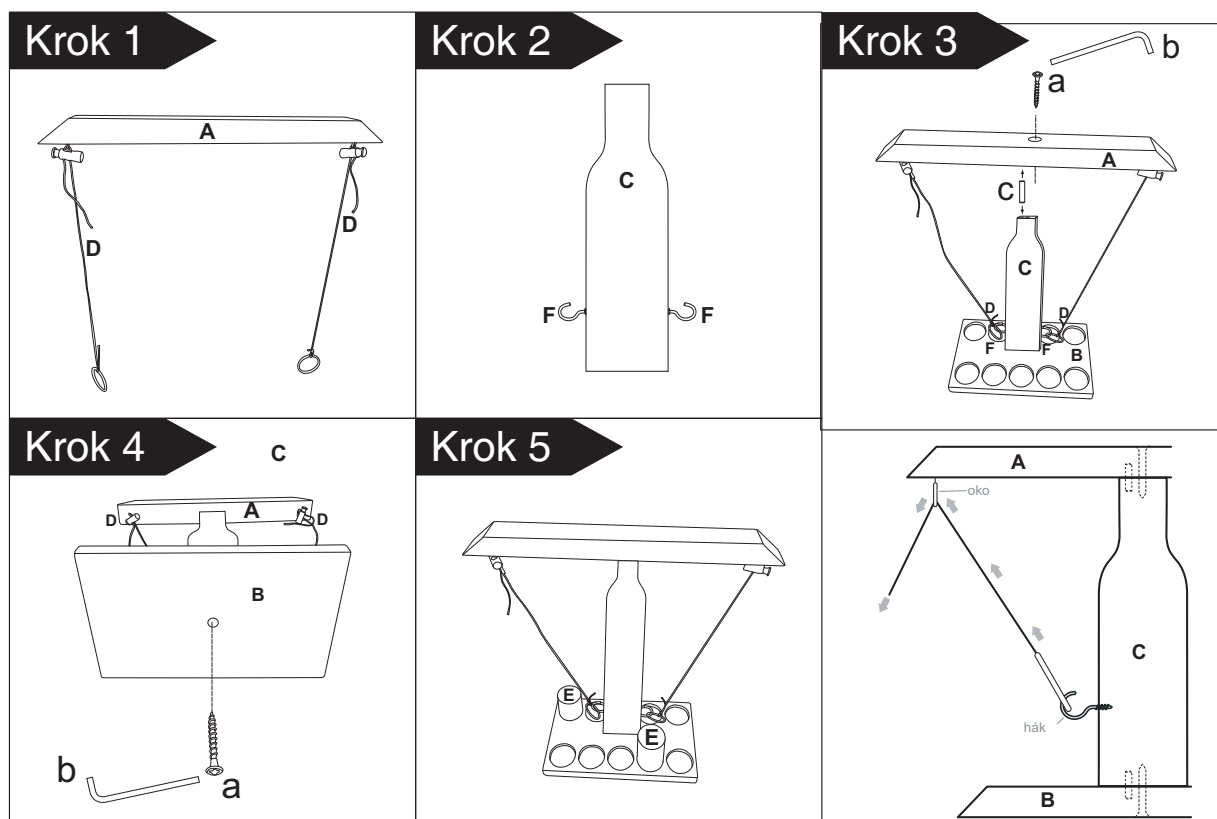

PRAVIDLA HRY

1. Položte dřevěného pšce nebo panáka na první kruh. Začněte odpočítávat a zároveň házet prsteny!
2. Pokaždé, když přistanete prsten na háku, posuňte dřevěným pšcem o 1 krok vpřed.
3. Vyhrává hráč, který dřevěného pšce nebo panáka posune na konec.

